

SE2 Flush and Pendant PTZs 30x

2MP 30X PTZs for indoor and outdoor applications



Pendant mount version, shown with wall mount/back box



Pendant mount version, shown with short mount/back box



Flush mount

Pendant mount



For customers who want to monitor a large area from multiple angles and perspectives with a single camera, the **SE2 PTZs** from March Networks® provide uncompromising security, indoors or outdoors. The camera's integrated HDR, 30X zoom lens, P-Iris, and 2MP resolution guarantee superior image quality, regardless of lighting conditions. Choose from the flush mount indoor model, or the outdoor pendant mount equipped with 1.5-inch NPT, which is protected by a weather-proof (IP66), vandal-resistant (IK10) enclosure.

Key Benefits



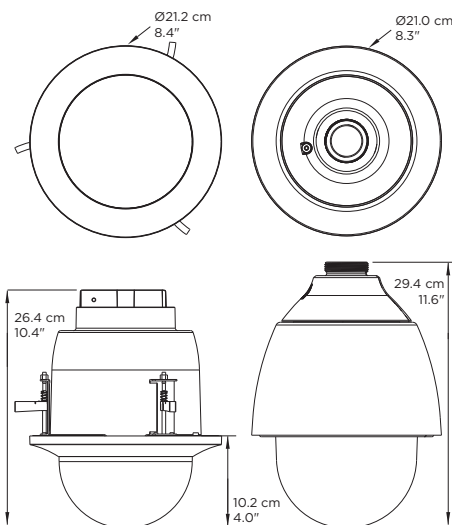



- ▶ **30X zoom lens.** Get a wide angle view of a large area with no distortion, and zoom in on distant objects, while maintaining clarity.
- ▶ **Built-in auto tracking.** The camera detects motion and tracks a person or object—automatically panning, tilting and zooming—to keep the image centered and in-focus.
- ▶ **High Dynamic Range (HDR).** The camera blends the best parts of several separate exposures together to combine the most focused, well-lit, and colorful parts of the scene.
- ▶ **Image stabilization.** Reduces vibration and blurring, especially when the camera is zoomed all the way in, or is installed up high or in a windy area.
- ▶ **Power over Ethernet.** Combining PoE+ with AC or DC guarantees zero downtime; if power goes out, the camera switches to PoE+ with no interruption.
- ▶ **Save money on storage and bandwidth.** When the camera is in its home position, its low bit rate (LBR) setting reduces storage and bandwidth usage by 50% or more in most applications; streams can drop below 2Mbps at 2MP (15 fps).



Flush mount

Pendant mount

MOUNTING OPTIONS FOR SE2 PENDANT PTZ

		
1.5" NPT Short Pendant Mount with Back Box	1.5" NPT Wall Mount with Back Box	1.5" NPT Pendant Mount
		
1.5" NPT Wall Mount	Corner Adaptor	Pole Adaptor

Maximize your level of protection while minimizing your surveillance costs.

SE2 Flush and Pendant PTZs 30x

LENS	
Optical Zoom	30X
Lens	4.3 – 129 mm, F1.6, P-Iris
Field of View	H = 67°(wide), 2°(tele); V = 38°(wide), 1°(tele)

CAMERA	
Image Sensor	1/2.8" Sony CMOS
Effective Pixels	2MP; 1945 (H) x 1097 (V)
Signal / Noise Ratio	>50 dB
Minimum Illumination	Color: 0.02 lux @ F1.6 (50 IRE) B/W: 0.012 lux @ F1.6 (50 IRE)
High Dynamic Range (HDR)	120 dB
Day/Night Functionality	True Day/Night
Pixel Size	2.5 µm
Shutter Speed	1/10000s
Camera Angle Adjustment	Pan 360°, Tilt 180°, Rotation -100° to 100°
White Balance	Manual/Automatic

VIDEO	
Video Compression	H.264, MJPEG
Resolution	2MP, Full HD 1080p, SXGA, 720p, XGA, SVGA, D1, VGA, CIF
Frame Rate (max)	H.264: HDR 1080p @ 30 fps + 1080p @ 30 fps MJPEG: 1080p @ 30 fps
Streaming	Up to four individually configurable streams in H.264, MJPEG. Configurable framerate, bandwidth, LBR, VBR, and CBR in H.264
Image Settings	Iris control, backlight compensation, white balance, noise reduction, wide dynamic range, privacy mask, brightness, exposure, sharpness, contrast, saturation, hue, IR configuration, day/night threshold

AUDIO	
Audio Streaming	Two-way, stereo
Audio Compression	G.711 PCM, G.726 ADPCM, Configurable bit rate (8-48 kHz)
Audio Input/Output	Line in/line out

OPERATIONAL	
Pan Manual Control Speed	0.1° - 90°/second
Tilt Manual Control Speed	0.1° - 55°/second
Pan Preset Speed	400°/second
Tilt Preset Speed	300°/second
Pan Rotation Angle	360° continuous rotation
Tilt Rotation	-10° - 100°
Pan Preset Accuracy	0.225°
Tilt Preset Accuracy	0.225°
Programmable Presets	256
Programmable Patterns	8
Autopan	4
Sequence	8
Auto Home	Yes
Motion Detection	Yes (4 areas)

NETWORK	
Security	Password protection, HTTPS encryption (configuration only), IEEE 802.1X
Supported Protocols	IPv4/v6, TCP/IP, UDP, RTP, RTSP, HTTP, HTTPS, DHCP, PPPoE, UPnP, QoS, ONVIF-S
Interface	RJ-45, 10/100Mbps Ethernet
Internet Browser	Internet Explorer (10+)

SYSTEM INTEGRATION	
Alarms	Four alarm inputs, two relay outputs
Intelligent Video	Video motion detection, privacy zones
Alarm Trigger	Motion detection, external input
Alarm Events	Video recording to local storage (standard SD card, 128 GB support), external output activation

CONNECTORS	
Terminal Block	Alarm in, alarm out, 12 VDC, 24 VAC, audio out, RS-485
RJ-45 Connector	Ethernet
CVBS BNC Connector	Analog video

ELECTRICAL	
Power	PoE (IEEE802.3at), 12 VDC (2.12 A), 24 VAC (1.06 A)
Power Consumption	25.4 Watts max

PHYSICAL	
Construction	Metal and plastic
Storage	Support for standard SD card, up to 128 GB Support for recording to NAS
Dimensions (H x D)	Flush: 10.4 x 8.4 in (26.4 x 21.2 cm) Pendant: 11 x 8.3 in (29.4 x 21.0 cm) includes sunshield
Weight	Flush: 5.7 lbs (2.6 kg) Pendant: 6.4 lbs (2.9 kg)
Operating Conditions	Flush: 13° to 140°F (-25° to 60°C) Pendant: -40° to 140°F (-40° to 60°C) with heater
Storage Conditions	-4° to 158°F (-20° to 70°C)
Humidity	10 - 90% RH, non-condensing
Weatherproof Standard	IP66 (Pendant Mount only)
Vandal Resistant	IK10 (Pendant Mount only)

REGULATORY	
Certification Model	Flush Mount = C3601A; Pendant Mount = C3701A
Emissions	EN 55032, FCC Part 15 Subpart B, ICES-003, AS/NZS CISPR 32
Immunity	EN50130-4
Safety	EN/IEC60950-1, UL/CSA60950-1
Environmental	ROHS2, WEEE

ORDERING INFORMATION	
CAMERA	
36860-101	SE2 Flush PTZ 30x (indoor only)
36861-101	SE2 Pendant PTZ 30x (indoor/outdoor)
ACCESSORIES	
36990*	1.5" NPT Short Pendant Mount with Back Box
HOMINIDOMESMA*	1.5" NPT Pendant Mount
36989*	1.5" NPT Wall Mount with Back Box
HOMINIDOMEWB*	1.5" NPT Wall Mount
HOMINIDOMEVMA*	Pole Adaptor
27639*	Corner Adaptor
36991	Single Port UPOE PTZ Power Injector
37273	SE2 Flush PTZ smoked bubble
37272	SE2 Pendant PTZ smoked bubble

* For use with SE2 Pendant PTZ 30x (36861-101)

5-year warranty:

- Option for Advance Replacement or Repair & Return.
- No need to issue a PO prior to receiving the replacement.
- March Networks incurs all shipping costs – both ways – for Advance Replacements.

North America 1 800 563 5564
Latin America +5255 5259 9511
Europe +39 0362 17935
Asia +65 6818 0963
Australia and New Zealand +61 1300 089 419
Middle East and Africa +971 4 399 5525

© 2021 March Networks. All rights reserved. Information in this document is subject to change without notice. MARCH NETWORKS, March Networks Command, March Networks Searchlight, March Networks RideSafe, and the MARCH NETWORKS logo are trademarks of March Networks Corporation. All other trademarks are the property of their respective owners. 060-3372-00-C marchnetworks.com

